

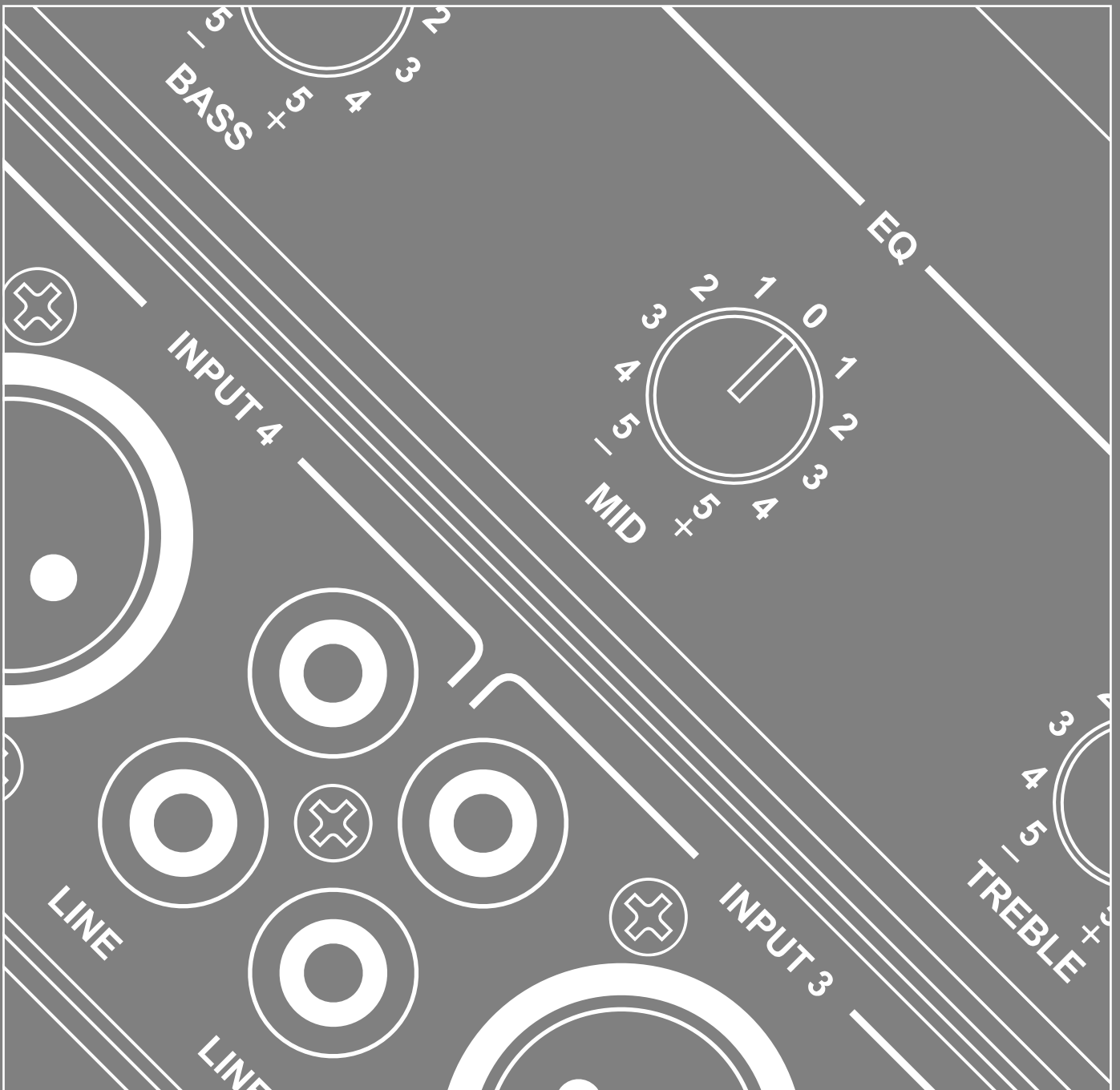

Australian Monitor
INSTALLATION SERIES

MX61

6 CHANNEL MIC/LINE MIXER
INSTALLATION AND OPERATION MANUAL





IMPORTANT SAFETY INFORMATION



1. Save the carton and packing material even if the equipment has arrived in good condition. Should you ever need to ship the unit, use only the original factory packing.
2. Read all documentation before operating your equipment. Retain all documentation for future reference.
3. Follow all instructions printed on unit chassis for proper operation.
4. Do not spill water or other liquids into or on the unit, or operate the unit while standing in liquid.
5. Make sure power outlets conform to the power requirements listed on the back of the unit.
6. Do not use the unit if the electrical power cord is frayed or broken. The power supply cords should be routed so that they are not likely to be walked on or pinched by items placed upon or against them, paying particular attention to cords and plugs, convenience receptacles, and the point where they exit from the appliance.
7. Always operate the unit with the AC ground wire connected to the electrical system ground. Precautions should be taken so that the means of grounding of a piece of equipment is not defeated.
8. Mains voltage must be correct and the same as that printed on the rear of the unit. Damage caused by connection to improper AC voltage is not covered by any warranty.
9. Have gain controls on amplifiers turned down during power-up to prevent speaker damage if there are high signal levels at the inputs.
10. Power down & disconnect units from mains voltage before making connections.
11. Never hold a power switch in the "ON" position if it won't stay there itself!
12. Do not use the unit near stoves, heat registers, radiators, or other heat producing devices
13. Do not block fan intake or exhaust ports. Do not operate equipment on a surface or in an environment which may impede the normal flow of air around the unit, such as a bed, rug, weathersheet, carpet, or completely enclosed rack. If the unit is used in an extremely dusty or smoky environment, the unit should be periodically "blown free" of foreign matter.
14. Do not remove the cover. Removing the cover will expose you to potentially dangerous voltages. There are no user serviceable parts inside.
15. Do not drive the inputs with a signal level greater than that required to drive equipment to full output.
16. Do not connect the inputs / outputs of amplifiers or consoles to any other voltage source, such as a battery, mains source, or power supply, regardless of whether the amplifier or console is turned on or off.
17. Do not run the output of any amplifier channel back into another channel's input. Do not parallel- or series-connect an amplifier output with any other amplifier output.

Australian Monitor Inc is not responsible for damage to loudspeakers for any reason.
18. Do not ground any red ("hot") terminal. Never connect a "hot" (red) output to ground or to another "hot" (red) output!
19. Non-use periods. The power cord of equipment should be unplugged from the outlet when left unused for a long period of time.
20. Service Information Equipment should be serviced by qualified service personnel when:
 - A. The power supply cord or the plug has been damaged.
 - B. Objects have fallen, or liquid has been spilled into the equipment
 - C. The equipment has been exposed to rain
 - D. The equipment does not appear to operate normally, or exhibits a marked change in performance
 - E. The equipment has been dropped, or the enclosure damaged.

THIS SAFETY INFORMATION IS OF A GENERAL NATURE AND MAY BE SUPERSEDED BY INSTRUCTIONS CONTAINED WITHIN THIS MANUAL

INTRODUCTION AND CONTENTS

The MX61 is a 6 channel audio mixer that operates from 110/230-240 VAC @ 50/60 Hz or 24 VDC via an external 24VDC supply.

The MX61 offers high quality audio performance & a wide array of features in a standard 1 RU size. For table mounting, rubber feet are supplied but these can be removed if rack mounting is intended.

There are six dual purpose inputs consisting of balanced XLR inputs switchable between mic & line level and dual RCA aux/line level inputs. Each input has front panel trim control and status LED. Priority muting is available as an optional addition as is remote VCA master control and tone generation.

The MX61 also features 3 stage master EQ, 4 segment LED output metering, & the ability to internally switch input 1 to be either pre or post master. With both Headphone out & Record out also available the

MX61 is extremely versatile & represents excellent value for money. Thankyou for purchasing the Australian Monitor Installation Series MX61.

INTRODUCTION	3
FRONT PANEL	4
REAR PANEL	5
INTERNAL ADJUSTMENTS	6
INSTALLATION & TROUBLESHOOTING	7
BASIC SETUP & OPERATION	8
DIMENSIONS	9
BLOCK DIAGRAM	10
SPECIFICATIONS	11

AUS, EUR, USA

Copyright 24th Jan 2006

Rev A 24/01/06

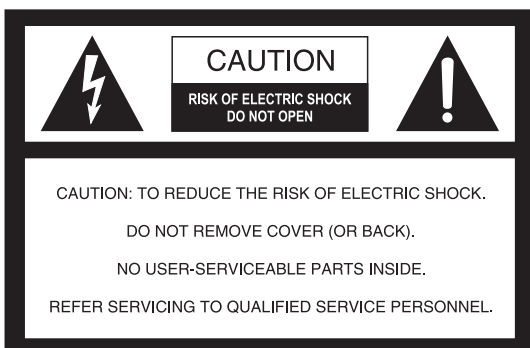

This symbol is intended to alert the user to the presence of uninsulated "dangerous voltage" within the product's enclosure that may be of sufficient magnitude to constitute a risk of electric shock to persons.



This symbol is intended to alert the user to the presence of important operation and maintenance (servicing) instructions in the literature accompanying the appliance.

Caution:

To prevent electric shock do not use this (polarised) plug with an extension cord, receptacle or other outlet unless the blades can be fully inserted to prevent blade exposure. To prevent electric shock, match wide blade of plug to wide slot, fully insert.

WARNING !

TO REDUCE THE RISK OF FIRE OR ELECTRIC SHOCK. DO NOT EXPOSE THIS EQUIPMENT TO RAIN OR MOISTURE.

FRONT PANEL

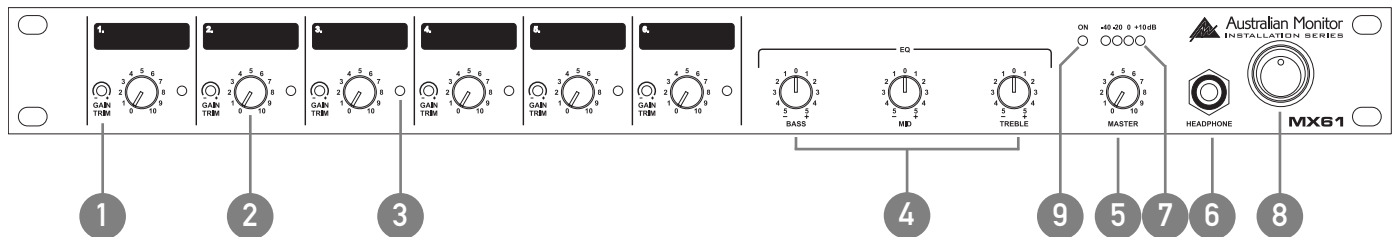

1 GAIN TRIM

This control is used to adjust the input gain and affects both the XLR and the RCA inputs.. The input gain can be adjusted by +/- 15dB. This allows a wide range of program sources to be set up with optimum gain structure. With the gain trim in the centre position, the boost/cut is set to 0dB. See the block diagram on page 10 for details of the gain structure.

2 LEVEL

Controls the level of the input signal.

3 INPUT STATUS LEDS

Each input has an LED status indicator. The LED is green when there is signal present and red if the signal is approaching clip. If the LED begins to light red this would indicate the internal signal level is 6dB before clip. Note that the front panel level control is post status LED and as such, the status LED is NOT affected by the level control. If an input channel is clipping use the gain control to adjust the correct amount of input level.

4 OUTPUT TONE CONTROLS

The output has a 3 band EQ.

Bass – +/-12dB 100Hz shelving

Mid – +/-12dB 1.6kHz, Q=1.4

Treble – +/-12dB 10kHz shelving

5 MASTER

This pot controls the overall mixed output.

6 HEADPHONE

This 1/4" jack socket allows headphones to be used for monitoring. It can be set as pre or post master volume control. See "Internal Adjustments" on page 6. Default factory setting is pre master volume control.

7 MASTER VU DISPLAY

This VU display indicates output level.

8 POWER SWITCH

This switch switches power from the mains. The up position is on.

NOTE: When using the 24VDC socket the unit is on regardless of switch position.

9 POWER ON LED

This indicates there is power to the unit.

NOTE: When using the 24VDC socket the power LED will always be on.

REAR PANEL

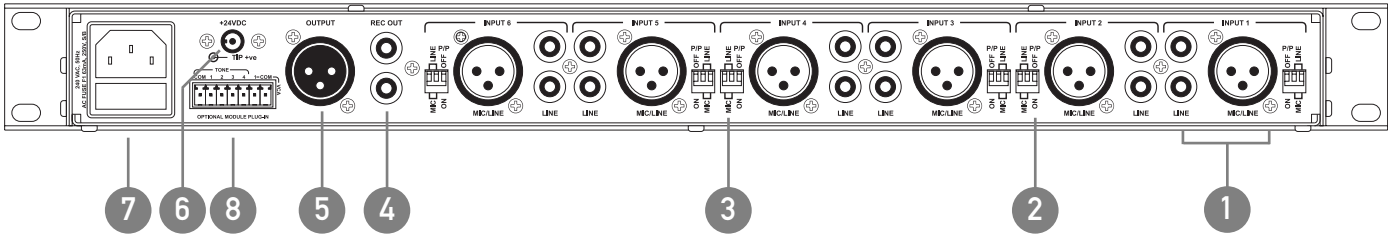

1 CHANNEL INPUTS

Each channel has two inputs:

XLR input - This is a balanced input. It accepts mic or line level signals depending on the adjacent gain switch position. The XLR will also have +15V phantom power if selected on the adjacent switch.

RCA input - This is an unbalanced line level input. The two RCA sockets are summed to mono internally.

2 P/P – PHANTOM POWER

15V phantom power is available for condenser or electret microphones on the XLR input when this switch is in the "ON" position.

3 MIC / LINE

These two switches control the sensitivity of the XLR input. In the "MIC" position the XLR input is suitable for use with microphones; in the "LINE" position the XLR input is suitable for use with a balanced line level signal.

NOTE: Both MIC/LINE switches must be in the same position for correct operation of the balanced input.

NOTE: The MIC/LINE switches only affect the XLR input.

4 REC OUT

The REC OUT output is on unbalanced RCA connectors. The output is dual mono and is not affected by the MASTER volume control or the EQ tone controls.

5 OUTPUT

The OUTPUT XLR provides balanced line level signal.

NOTE: When wiring the LINE output as unbalanced, Pin2 should be wired as hot and Pin1 should be wired as ground/shield. Do not wire Pin3.

6 24VDC SOCKET

This 2.1mm x 5.5mm barrel socket is provided for 24V emergency systems and is not switched by the front panel power switch.

NOTE: The 24VDC socket does not provide trickle charge facility. Tip of the connector is positive.

7 IEC MAINS INPUT SOCKET

This is a standard IEC 3 pin socket. It accepts a standard IEC mains cable, provided. The fuse draw contains the mains fuse and a spare. The mains fuse is a time lag (slow blow) HRC 20mm x 5mm ceramic type fuse.

The ratings are:

230V/240V model 63mA

115V model 120mA

! Always replace the fuse with one of the same value and type.

! NOTE: Always disconnect power to the amplifier before replacing fuses.

8 OPTIONAL MODULE INPUTS

This socket is used with a tone module and/or VCA module.

INTERNAL ADJUSTMENTS

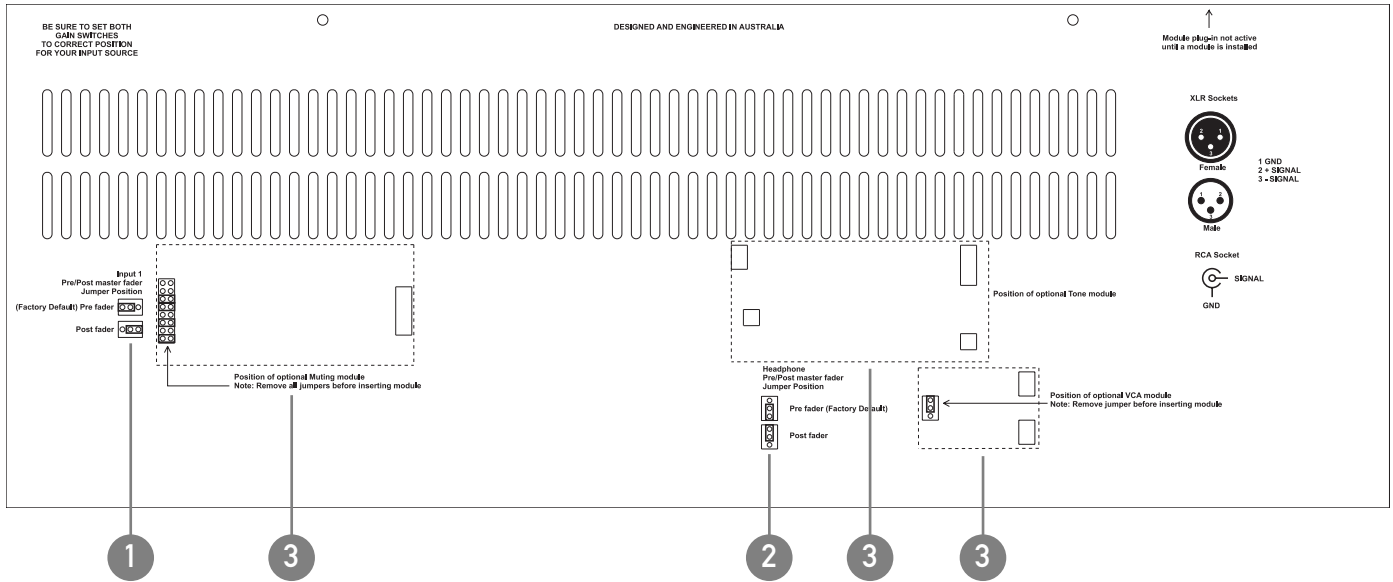

1 CHANNEL 1 ROUTING

If channel 1 is being used as a priority input it can be routed so that the master volume does not affect channel 1. The default factory setting is pre master fader meaning the master volume affects channel 1 in the mix. The jumper header is located mid way above channel 1 pot. Move the jumper to link the two pins nearer channel 8 to set channel 1 to post master fader.

2 HEADPHONE ROUTING

The headphone level can be routed so that it is affected by the master volume. The default factory setting is pre master fader meaning the master volume does not affect the headphone volume. The jumper header is located just behind the front panel above channel 6 pot. Move the jumper to link the two pins nearer the inputs to set the headphone to post master fader.

3 OPTIONAL MODULES

The MX61 can have installed:

- a VCA module
- a Tone Generator module
- a Priority Muting module

See your local Australian Monitor dealer for more information.

INSTALLATION & TROUBLESHOOTING

INPUT CONNECTIONS

For wiring balanced in, pin 2 is hot. Unbalanced wiring on the microphone inputs is not recommended. Balanced input wiring (shielded pair cable) is recommended.

Unbalanced RCA wiring should be kept as short as possible. Typically less than 3m.

LINE OUTPUT

The LINE output XLR can be used to connect up to 6 booster amplifiers. Balanced wiring (shielded pair cable) is recommended.

NOTE: When wiring the LINE output as unbalanced, Pin2 should be wired as hot and Pin1 should be wired as ground/shield. Do not wire Pin3.

RECORD OUTPUT.

The Record output wiring should be kept as short as possible. Typically less than 3m.

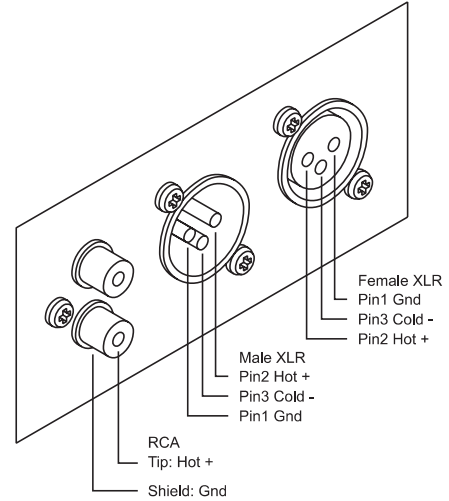

TROUBLE	LIKELY CAUSE	REMEDY
Power LED not on	Power not reaching unit	Check mains connection Check mains fuse Check power switch is on
Poor S/N ration	Incorrect gain structure	See setup guide
Distorted sound	Input is overloaded	Reduce input gain Reduce input level at source
	Output is being over driven	Reduce output volume
No sound but unit is on	Volume turned down	Check volume controls
Tones and/or VCA control does not work	Module not installed	Purchase optional modules
Condenser microphone does not work	Phantom power not switched on	Switch on phantom power

BASIC SETUP & OPERATION

The inputs of the MX61 can accommodate a wide range of sources including dynamic microphones, DVD and CD players. The output may be used to drive power (booster) amplifiers, other mixers or mixer amplifiers.

Each installation will require setting the appropriate relative mix of levels between microphones and program. Because of the variation in levels between the possible sources, the MX61 offers a number of gain stage adjustments so you can set the correct levels for your application. Also consider what the output is driving. . .

Setting up correct gain structure through the whole system is important to achieve optimal results. The following step by step procedure has been devised to assist during the setup process. When the MX61 was shipped to you from the factory, it was set up in a particular way. In the following procedure it is essential that you are starting from these initial settings.

- Program Input Gain Controls – half (12 o'clock)
- XLR Mic/Line switch – MIC
- XLR Phantom power - on
- Input Level Controls – off
- Output Level Control – off

STEP BY STEP SETUP

1 CONNECT THE SOURCES

First connect all the required sources to the appropriate input connectors. If the source is a microphone, set the MIC/LINE switches to the "MIC" position. If the source is an electret or condenser microphone, set the phantom switch to the "P/P on" position.

2 CONNECT THE OUTPUTS

Turn the amplifiers off. Connect the MX61 output to the amplifiers' line level input. Check that the MX61 is on, and then turn on the amplifiers. If the amplifiers have a level control, set them to a sensitivity of 0dBu. If in doubt, set it to maximum.

3 TEST THE INPUT LEVELS

For each source, try to achieve the highest signal level possible. i.e. for a CD player, cassette deck or other music source, put on the loudest anticipated program music or for a paging mic make a 'loud' page. During this signal condition, the input status LED should light green and may occasionally turn red for a short period.

If the status LED stays red (more than 10% of the time), you should reduce the input gain trim. If the status LED never turns red at all, you may wish to increase the input gain trim if required.

4 SET THE LEVELS

Turn the input levels up to 5. Turn up the output level until it is at an appropriate level for the listening environment. You will now have to adjust the relative levels of the inputs to achieve a good balance. The aim of these adjustments is to have all level controls at between 3 and 7. This may not be possible however. A good rule of thumb is that input level controls should be higher than the output level controls.

DIMENSIONS

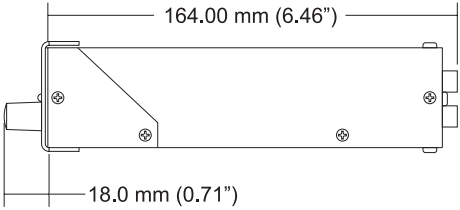
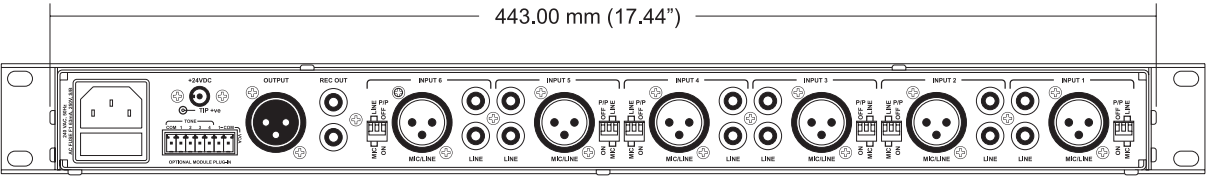
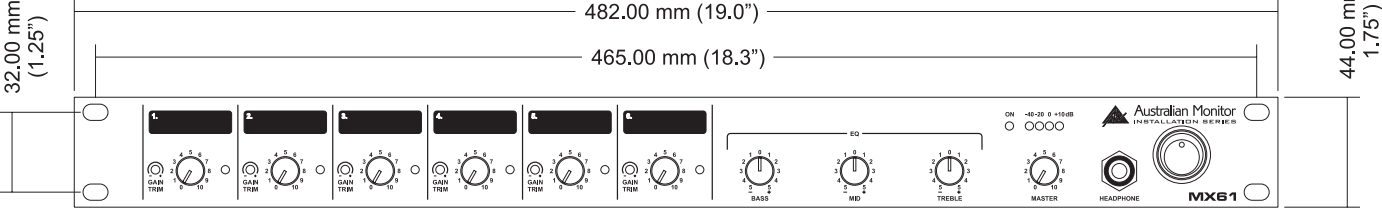

BLOCK DIAGRAM

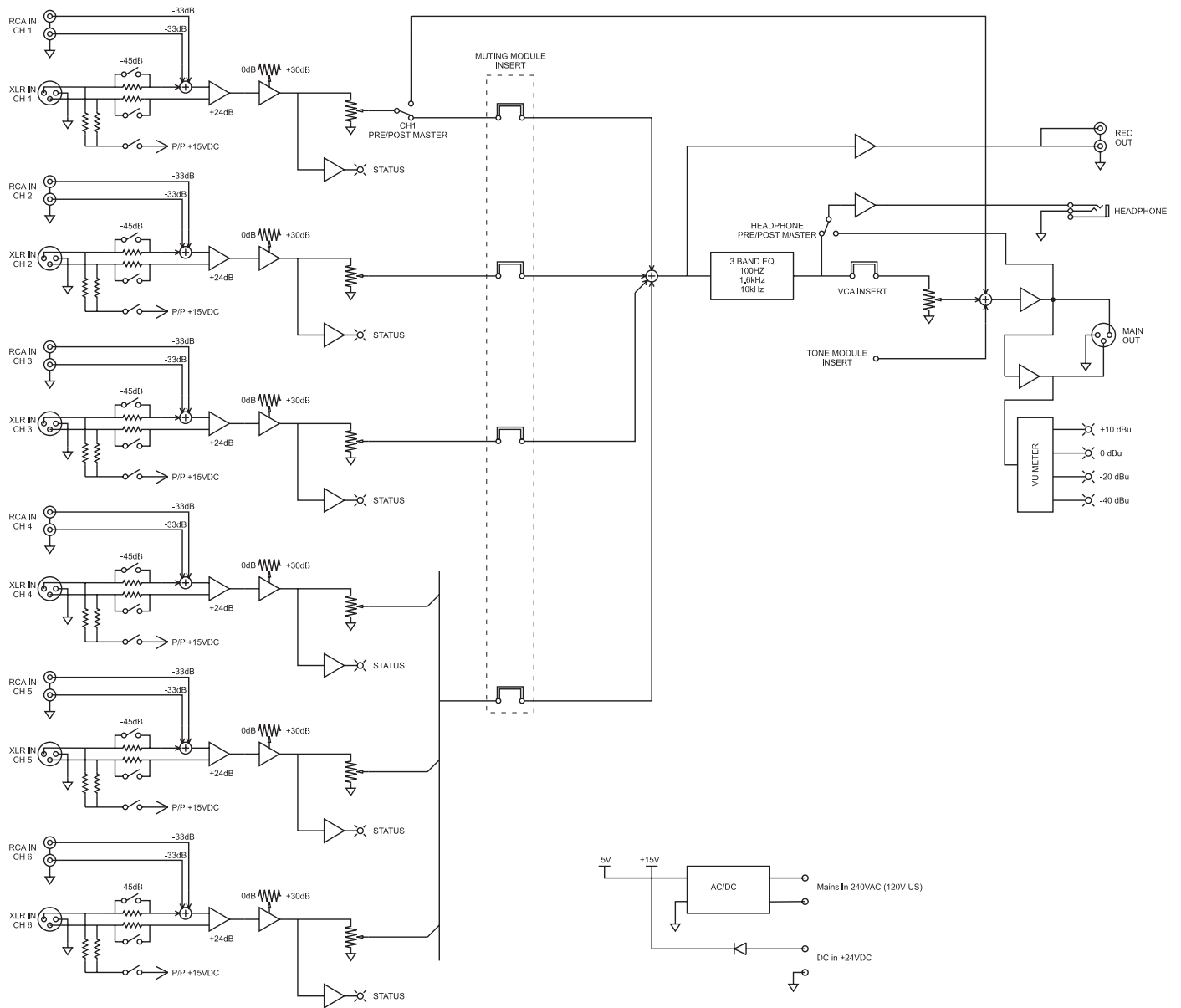

SPECIFICATIONS

FREQUENCY RESPONSE 20Hz - 20kHz (+0,-3dB)

TOTAL HARMONIC DISTORTION < 0.1% @ 1kHz

SIGNAL TO NOISE RATIO > 90dB (all pots at centre position)

CROSSTALK >70dB

TONE CONTROLS

BASS @ 100HZ +/- 12dB
 MID @ 1.6KHZ +/- 12dB
 TREBLE @ 10KHZ +/- 12dB

SENSITIVITY (Trim in centre 0dB) Mic Sens 4.36mV, -45dBu Imp 1k3ohm
 Line Sens 0.775V, 0dBu Imp >100k
 RCA 200mV, -12dBu Imp 30kohm

MAX LEVEL IN XLR mic -15dBu line +30dBu
 RCA >30dBu

MAX LEVEL OUT +21dBu

PHANTOM POWER 15V DC

OUTPUTS

MASTER OUT Nominal Level 0dBu into 1kohm
 Imp 100ohm
 MONO HEADPHONE OUT Nom -6dB into 200ohm
 Imp 10ohm
 MONO REC OUT Nom -12dB into 10kohm
 Imp 10kohm

POWER INPUT AC: 230V/50Hz or 115V/60Hz,
 3 pin IEC320-C14 connector;
 DC: 24 Volts via 2.1mmx5.5mm DC socket

POWER CONSUMPTION (MAX) 7 VA

FUSES

MAINS (115V) 120mA
 MAINS (230V) 63mA

DIMENSIONS h x w x d 44mm x 482mm x 182mm
 (1.75"x19"x7.2")

SHIPPING DIMENSIONS h x w x d 90mm x 505mm x 270mm
 (3.5"x19.9"x10.6")

WEIGHT

NET 2.75kg (6.1lb)
 SHIPPING 3.75kg (8.3lb)

AUSTRALIA AND NEW ZEALAND

www.australianmonitor.com.au

SYDNEY

(NSW & ACT SALES)

149 Beaconsfield
Street Silverwater
NSW 2128
Private Bag 149
Silverwater NSW 1811
Phone: (02) 9647 1411
Fax: (02) 9648 3698
Email:
nsw@audiotel.com.au

MELBOURNE

(VIC & TAS SALES)

22/277
Middleborough Road
Box Hill VIC 3128
PO Box 151 Blackburn
South VIC 3130
Phone: (03) 9890 7477
Fax: (03) 9890 7977
Email:
vic@audiotel.com.au

BRISBANE

(QLD SALES)

42 Commercial Road
Fortitude Valley
QLD 4006
PO Box 871 Fortitude
Valley QLD 4006
Phone: (07) 3852 1312
Fax: (07) 3252 1237
Email:
qld@audiotel.com.au

ADELAIDE

(SA & NT SALES)

31 Walsh Street
Thebarton
SA 5031
PO Box 157
Hindmarsh SA 5007
Phone: (08) 8352 4444
Fax: (08) 8352 4488
Email:
sa@audiotel.com.au

PERTH

(WA SALES)

299 Fitzgerald Street
West Perth WA 6005
PO Box 404
North Perth
WA 6906
Phone: (08) 9228 4222
Fax: (08) 9228 4233
Email:
wa@audiotel.com.au

AUCKLAND

(NZ SALES)

Unit B, 11 Piermark
Drive Albany 1331
New Zealand
PO Box 512
Albany 1331
Phone: (09) 415 9426
Fax: (09) 415 9864
Email:
sales@audiotel.co.nz

EUROPE/ASIA/MIDDLE EAST

www.australianmonitor.com.au

INTERNATIONAL SALES

149 Beaconsfield Street Silverwater NSW 2128 Australia
Private Bag 149 Silverwater NSW 1811
Phone: 61 2 9647 1411
Fax: 61 2 9648 3698
Email: international@audiotel.com.au

USA/SOUTH AMERICA

www.australianmonitor.com

SENNHEISER ELECTRONIC CORPORATION

1 Enterprise Drive
Old Lyme CT 06371 USA
Phone: 1 860 434 9190
Fax: 1 860 434 1759
Email: jalexander@sennheiserusa.com