

ZONER16

16 ZONE PAGING AND BGM SWITCHER
INSTALLATION AND OPERATION MANUAL

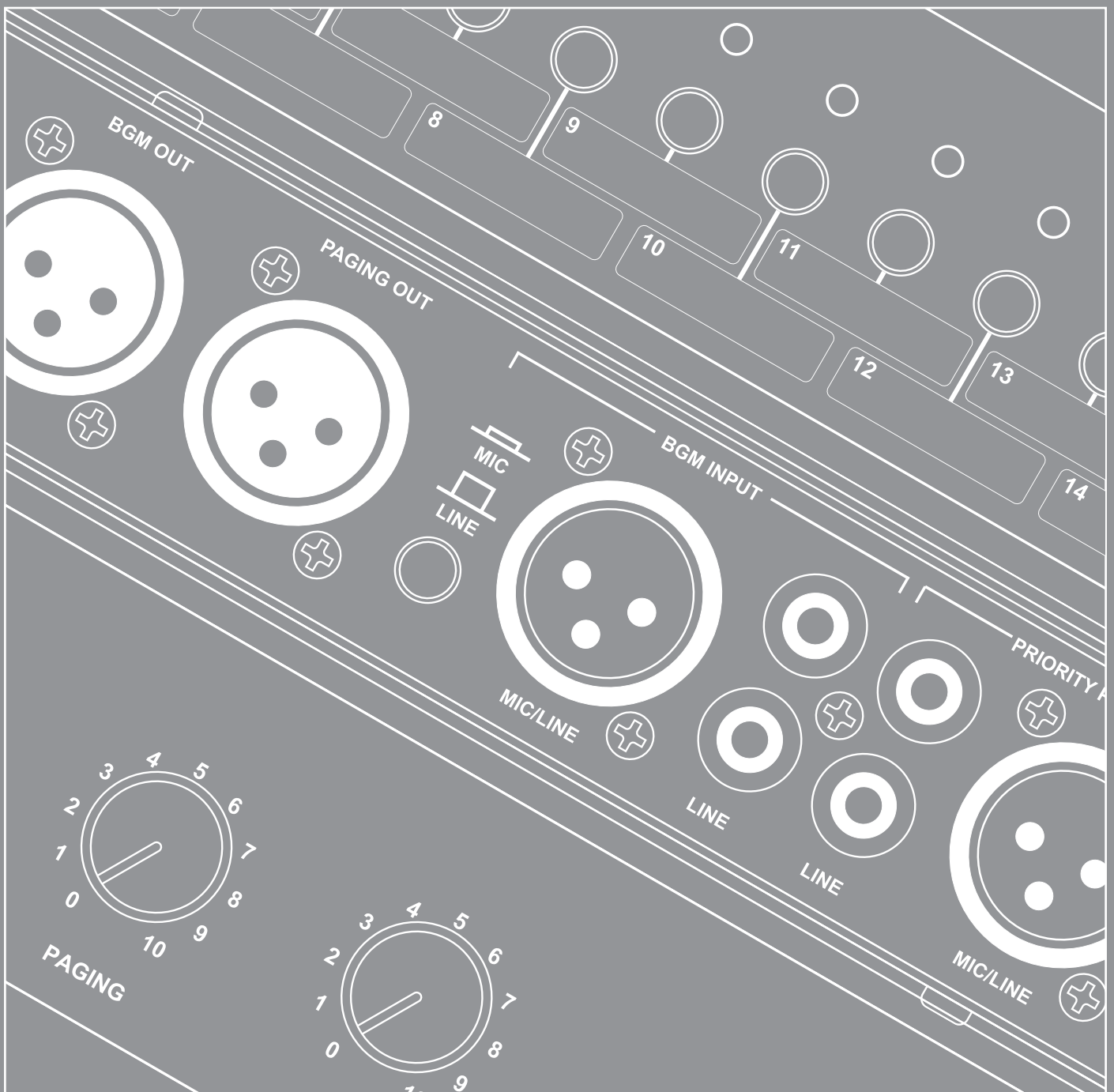



IMPORTANT SAFETY INFORMATION



1. Save the carton and packing material even if the equipment has arrived in good condition. Should you ever need to ship the unit, use only the original factory packing.
2. Read all documentation before operating your equipment. Retain all documentation for future reference.
3. Follow all instructions printed on unit chassis for proper operation.
4. Do not spill water or other liquids into or on the unit, or operate the unit while standing in liquid.
5. Make sure power outlets conform to the power requirements listed on the back of the unit.
6. Do not use the unit if the electrical power cord is frayed or broken. The power supply cords should be routed so that they are not likely to be walked on or pinched by items placed upon or against them, paying particular attention to cords and plugs, convenience receptacles, and the point where they exit from the appliance.
7. Always operate the unit with the AC ground wire connected to the electrical system ground. Precautions should be taken so that the means of grounding of a piece of equipment is not defeated.
8. Mains voltage must be correct and the same as that printed on the rear of the unit. Damage caused by connection to improper AC voltage is not covered by any warranty.
9. Have gain controls on amplifiers turned down during power-up to prevent speaker damage if there are high signal levels at the inputs.
10. Power down & disconnect units from mains voltage before making connections.
11. Never hold a power switch in the "ON" position if it won't stay there itself!
12. Do not use the unit near stoves, heat registers, radiators, or other heat producing devices.
13. Do not block fan intake or exhaust ports. Do not operate equipment on a surface or in an environment which may impede the normal flow of air around the unit, such as a bed, rug, weathersheet, carpet, or completely enclosed rack. If the unit is used in an extremely dusty or smoky environment, the unit should be periodically "blown free" of foreign matter.
14. Do not remove the cover. Removing the cover will expose you to potentially dangerous voltages. There are no user serviceable parts inside.
15. Do not drive the inputs with a signal level greater than that required to drive equipment to full output.
16. Do not connect the inputs / outputs of amplifiers or consoles to any other voltage source, such as a battery, mains source, or power supply, regardless of whether the amplifier or console is turned on or off.
17. Do not run the output of any amplifier channel back into another channel's input. Do not parallel- or series-connect an amplifier output with any other amplifier output. Australian Monitor Inc is not responsible for damage to loudspeakers for any reason.
18. Do not ground any red ("hot") terminal. Never connect a "hot" (red) output to ground or to another "hot" (red) output!
19. Non-use periods. The power cord of equipment should be unplugged from the outlet when left unused for a long period of time.
20. Service Information Equipment should be serviced by qualified service personnel when:
 - A. The power supply cord or the plug has been damaged.
 - B. Objects have fallen, or liquid has been spilled into the equipment
 - C. The equipment has been exposed to rain
 - D. The equipment does not appear to operate normally, or exhibits a marked change in performance
 - E. The equipment has been dropped, or the enclosure damaged.

THIS SAFETY INFORMATION IS OF A GENERAL NATURE AND MAY BE SUPERSEDED BY INSTRUCTIONS CONTAINED WITHIN THIS MANUAL

INTRODUCTION AND CONTENTS

The Zoner 16 is the entry level AMIS zoning product. A simple 16 zone output switcher with much more - providing remote paging facility, zone BGM enable buttons, LED BGM indication per active zone, zone output relays and separate BGM and paging inputs.

The Zoner 16 provides support for one 16 zone remote paging station, as well as one "All Call" priority paging input with contact closure logic triggering to route the priority paging input to all zones.

The Zoner 16 make multiple zone BGM selection and remote multiple zone paging a simple task indeed.

Thank you for purchasing the Australian Monitor Zoner 16.

INTRODUCTION	1
FRONT PANEL	2
REAR PANEL	3
INSTALLATION & TROUBLESHOOTING	4
DIMENSIONS	5
BLOCK DIAGRAM	6
SPECIFICATIONS	7

AUS, EUR, USA
Rev A 30/03/07

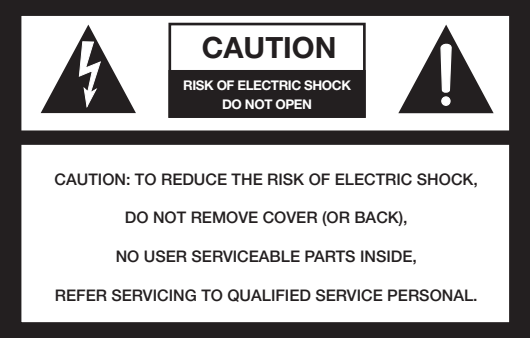

WARNING!
TO REDUCE THE RISK OF FIRE OR ELECTRIC SHOCK
DO NOT EXPOSE THIS EQUIPMENT TO RAIN OR MOISTURE.



This symbol is intended to alert the user to the presence of uninsulated "dangerous voltage" within the products enclosure that may be of sufficient magnitude to constitute a risk of electric shock to persons.



This symbol is intended to alert the user to the presence of important operational and maintenance (servicing) instructions in the literature accompanying the appliance.

Caution: To prevent electric shock do not use this (polarised) plug with an extension cord, receptacle or other outlet unless the blades can be fully inserted to prevent blade exposure. To prevent electric shock, match wide blade of plug to wide slot, fully insert.

FRONT PANEL

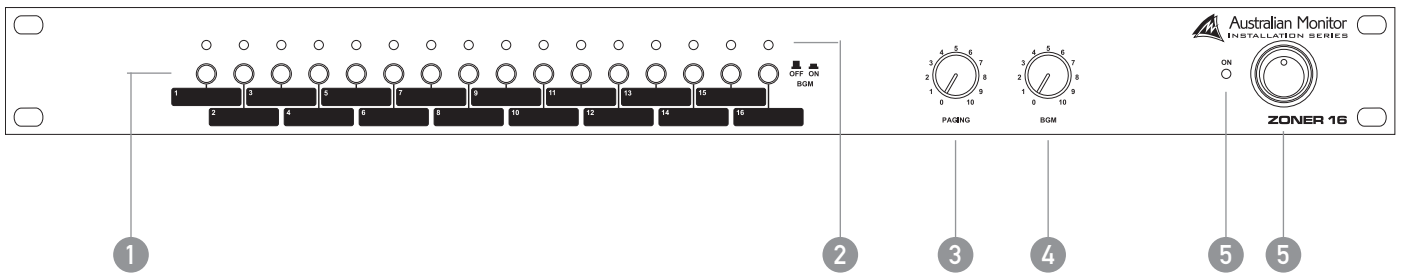

1 BGM ON/OFF SWITCH

These switches turn the BGM amplifier input ON or OFF to the corresponding ZONE OUTPUT

2 BGM ON/OFF LED

These LED's indicate if the BGM amplifier input is routed to the corresponding ZONE OUTPUT. Label space is provided to write the name of each zone.

3 PAGING LEVEL

This pot controls the level of the XLR output signal of the PAGING channel. It affects both the Paging Station and the Mic/Line XLR & RCA priority paging input.

4 BGM LEVEL

This controls the overall level of the background music.

5 POWER LED ON

This LED indicates the unit is powered "on".

 NOTE: When using the 24VDC in socket, the amplifier is 'on' and the power LED will always be on regardless of the position of the power switch.

6 POWER SWITCH

This switch switches power on or off from the mains. The up position is on.

 NOTE: When using the 24VDC in socket, the amplifier is 'on' regardless of the switch position.

REAR PANEL

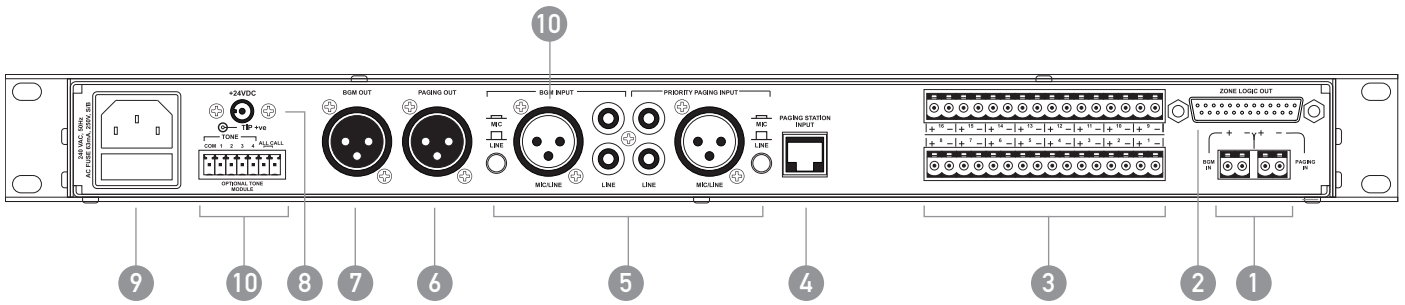

1 BGM and PAGING IN

These pluggable terminal blocks connect the speaker outputs of the amplifiers used for the PAGING and BGM sources respectively.

2 ZONE LOGIC OUT

This 25pin D-connector is used to control external devices. They can be used to drive relays for attenuator bypass. The outputs are open collector pull up, 24V 100mA drive. The total drive capacity is 150mA. This table shows an example of the possible combinations.

Number of relays per zone

Zone 1	Zone 2	Zone 3	Zone 4	Zone 5	Zone 6
4	2				
4	1	1			
3	3				
3	2	1			
3	1	1	1		
2	2	2			
2	2	1	1		
2	1	1	1	1	
1	1	1	1	1	1

This is based on the attenuators sold by Australian Monitor. Other manufactures may have different drive requirements.

If more attenuator drive is required use an external drive box is required with more power.

The pins of the D-connector correspond to each zone (e.g. Pin 3 is for Zone 3). Pins 17-25 are common ground.

3 ZONE OUTPUTS

These pluggable terminal blocks connect to the speaker runs for each respective zone.

4 PAGING STATION INPUT

This RJ45 socket accepts the CAT5 cable from the PAGING STATION.

5 BGM and PRIORITY PAGING INPUTS

Both these channels have two inputs:
XLR input - This is a balanced input. It accepts mic or line level signals depending on the gain switch position.
RCA input - This is an unbalanced line level input. The two RCA sockets are summed to mono internally.

6 PAGING OUT

The PAGING OUT XLR provides balanced line level signal. The level of this output is set by the PAGING LEVEL control on the front panel. Both the XLR/RCA PRIORITY PAGING INPUT and the PAGING STATION INPUT are mix to this output. The PRIORITY PAGING INPUT has priority over the remote PAGING STATION INPUT.

The PAGING OUTPUT (6) is to be connected to a paging amplifier. The paging amplifier output is to be connected to the PAGING IN connector (1)

NOTE: When wiring the LINE output as unbalanced, Pin2 should be wired as hot and Pin1 should be wired as ground/shield. Do not wire Pin3.

7 BGM OUT

The BGM OUT XLR provides balanced line level signal. The level of this output is set by the BGM LEVEL control on the front panel. This output is not affected by the PRIORITY PAGING or PAGING STATION INPUT.

The BGM OUT (7) is to be connected to a BGM amplifier. The BGM amplifier output is to be connected to the BGM IN connector (1)

NOTE: When wiring the LINE output as unbalanced, Pin2 should be wired as hot and Pin1 should be wired as ground/shield. Do not wire Pin3.

8 24VDC SOCKET

This 2.1mm x 5.5mm barrel socket is provided for 24V emergency systems and is not switched by the front panel power switch.

NOTE: The 24VDC socket does not provide trickle charge facility. Tip of the connector is positive.

9 IEC MAINS INPUT SOCKET

This is a standard IEC 3 pin socket. It accepts a standard IEC mains cable, provided. The fuse draw contains the mains fuse and a spare. The mains fuse is a time lag (slow blow) HRC 20mm x 5mm ceramic type fuse.

The ratings are:
230V/240V model 63mA
115V model 120mA

IMPORTANT: Always replace the fuse with one of the same value and type.

NOTE: Always disconnect power to the Zoner 16 before replacing fuses.

10 OPTIONAL MODULE INPUTS

This socket is used with a tone module and/or VCA module.

INSTALLATION EXAMPLE

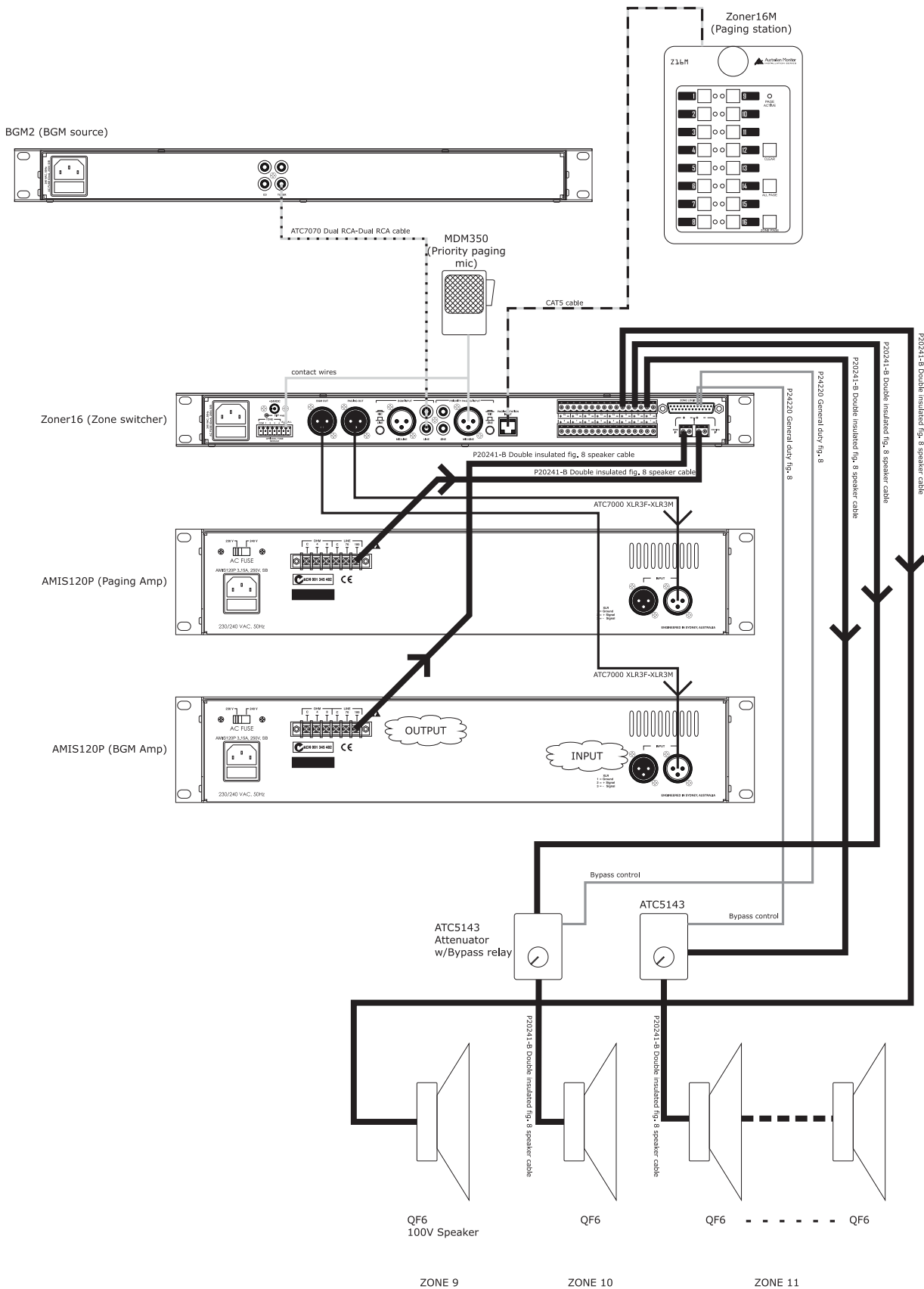

INTERNAL ADJUSTMENTS & INSTALLATION / TROUBLESHOOTING

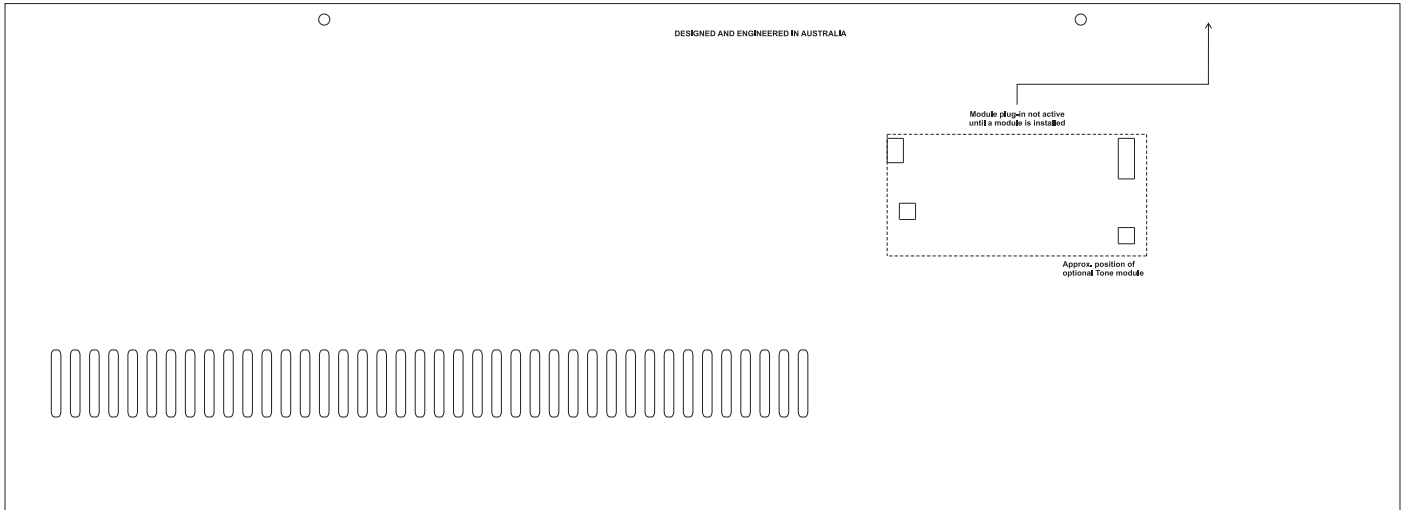

The only internal access required is for the installation of an Australian Monitor tone generator module. Installation is easy and is done by inserting the module onto the appropriate headers.

INPUT CONNECTIONS

For wiring balanced in, pin 2 is hot. Balanced input wiring (shielded pair cable) is recommended.

Unbalanced RCA wiring should be keep as short as possible. Typically less than 3m.

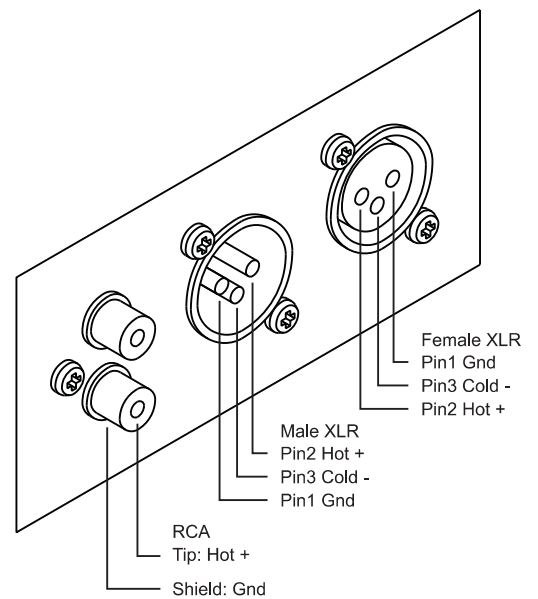

TROUBLESHOOTING GUIDE

TROUBLE	LIKELY CAUSE	REMEDY
Power LED not on	Power not reaching unit	Check mains connection Check mains fuse Check power switch is on
Distorted sound	Output is being over driven	Reduce output volume
No sound but amp is on	Volume controls down	Check volume controls

Z16M PAGING STATION

INTRODUCTION

The Australian Monitor Installation Series Zoner16M Paging Station is a 16 zone paging station complete with a slimline gooseneck paging microphone. The Paging station is designed to be used with the Zoner16 Zone Switching System and will allow paging into any individual zone, any combination of zones or All Call to all zones. LED indicators provide the user with visual feedback of the zones being paged or if the priority local paging All Call is busy. Ample label space is provided on the paging station. Connection to the Zoner16 is via low cost CAT 5 cable and as with all Australian Monitor installation products the paging station provides an elegant solution at a contractor friendly price.

CONTROLS

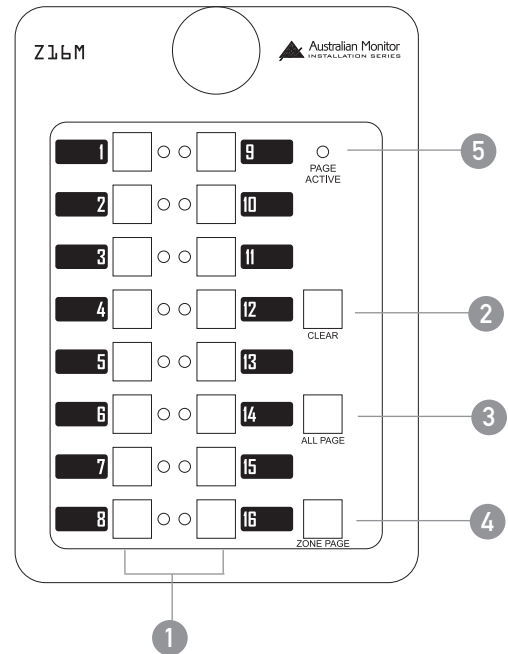

1 ZONE SELECT

These buttons allow selection of zones for paging. When selected, the adjacent LED glows green. Pressing the button again deselects the zone. The area next to the button is for labelling the zone. Selecting a zone does not instigate paging. See 4. ZONE PAGE.

2 CLEAR

This button clears all the selected zones.

3 ALL PAGE

This button pages to all zones. It is momentary so must be held while talking into the microphone. It activates the microphone and mutes the program sources. It does NOT clear the current zone selection configuration so the paging station will return to its previous state (selected zones) once the ALL PAGE button is released.

4 ZONE PAGE

This button pages to the current zone selection configuration as indicated by the ZONE select LED's. The zones being paged have their BGM sources muted and the microphone becomes active.

5 PAGING ACTIVE

This LED glows when the paging station is being used (you are making a page). It flashes when the main unit priority All Call is being used. Paging is not possible while this is flashing, however zone selections can still be made.

INSTALLATION AND SETUP

The CAT5 cable connects to the RJ45 socket on the rear panel of the paging station. This socket is a NEUTRIK™ connector designed to be used with the XLR style housing (model NE8MC) to improve reliability. Normal RJ45 connectors can also be used.

Plugging and unplugging the cable while the system is powered up may result in the system locking up and is not recommended. If this should happen, reset the Zoner16 by switching off, then on.

GAIN

To accommodate different speech levels, there is a gain control on the base of the Zoner16M. This control ships set to minimum and may be adjusted to suit. Increasing this control too far may cause the paging station to distort if loud or close speech levels are encountered.

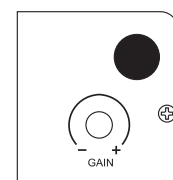

DIMENSIONS

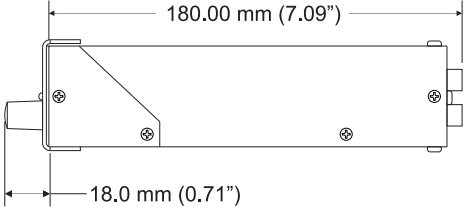
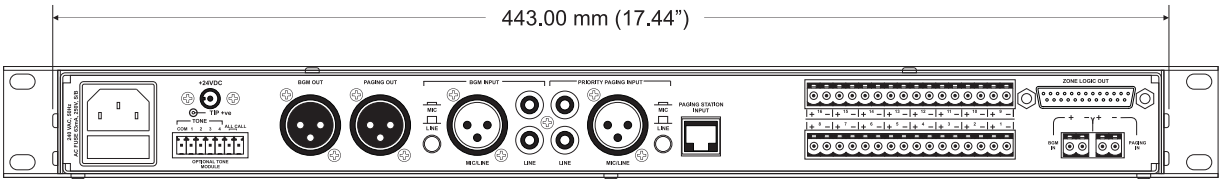
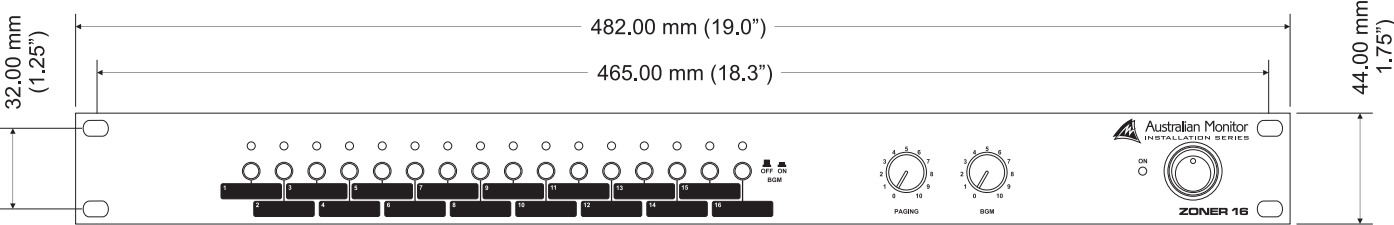

BLOCK DIAGRAM

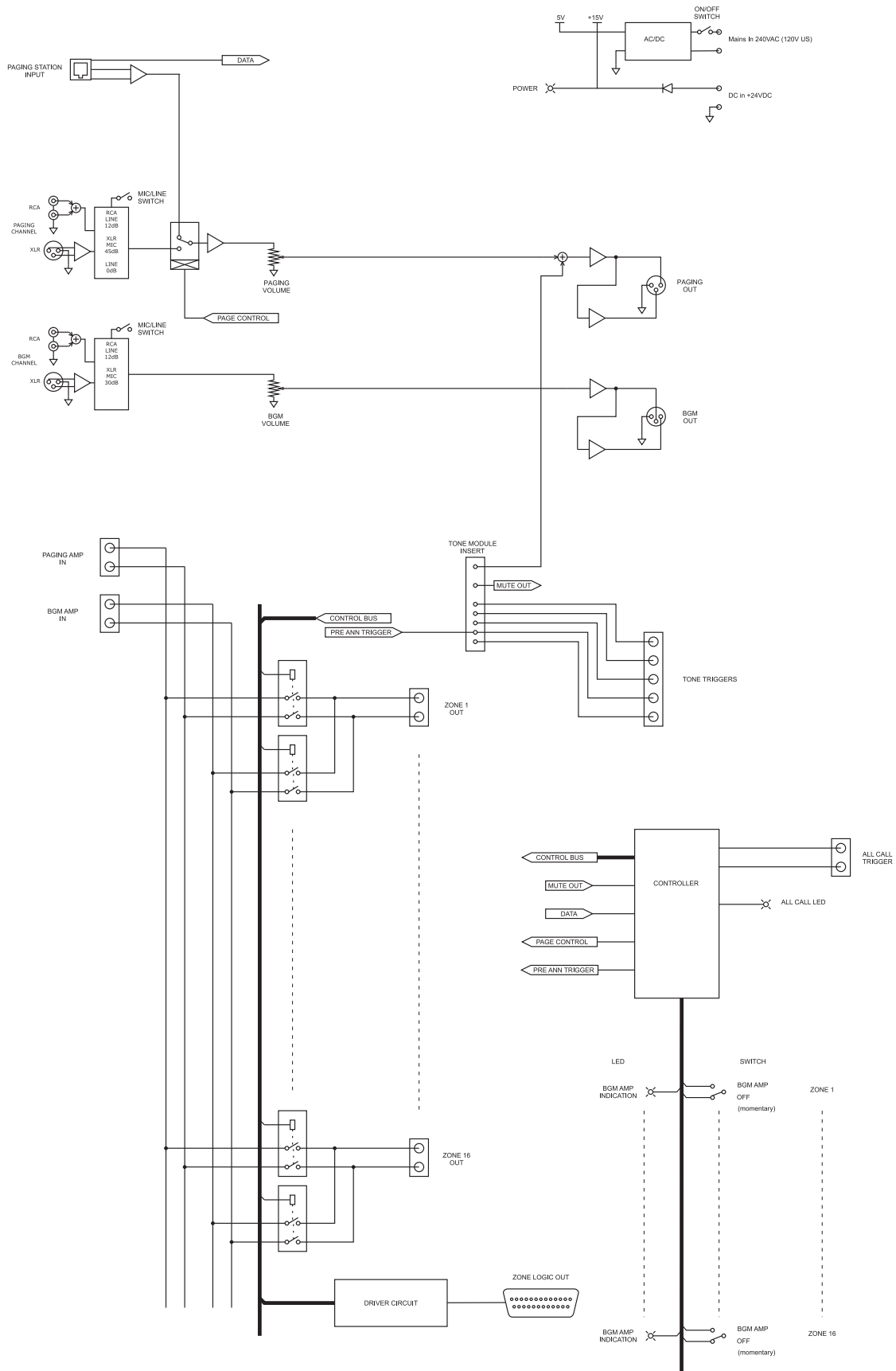

SPECIFICATIONS

FREQUENCY RESPONSE	20Hz - 20kHz (+0,-3dB)
TOTAL HARMONIC DISTORTION	< 0.1% @ 1kHz
SIGNAL TO NOISE RATIO	> 90dB (all pots at centre position)
CROSSTALK BETWEEN CHANNELS	>70dB
SENSITIVITY (TRIM IN CENTRE 0dB)	Line Sens 0.775V, 0dB Imp >100k RCA 200mV, -12dB Imp 30kohm
MAX LEVEL IN	XLR mic -9dBu line >30dBu RCA >30dBu
MAX LEVEL OUT	+27dBu
MAX AMPLIFIER POWER INPUT	100V, 500W 70V, 350W 4Ω, 100W
OUTPUTS	Nominal Level 0dBu into 1kohm Imp 100ohm
ZONE LOGIC OUTPUT DRIVE	150MA (24V)
POWER INPUT	AC: 230V/50Hz or 115V/60Hz, 3 pin IEC320-C14 connector
POWER CONSUMPTION (MAX)	15 VA
FUSES	
	MAINS (115V) 120mA
	MAINS (230V) 63mA
DIMENSIONS HXWXD	90mm x 505mm x 270mm (3.5"x19.9"x10.6")
WEIGHT	Net 2.8kg (6.2lb) Shipping 3.8kg (8.4lb)

AUSTRALIA AND NEW ZEALAND

www.australianmonitor.com.au

SYDNEY

(NSW & ACT SALES)

1 Clyde Street
Silverwater
NSW 2128
Private Bag 149
Silverwater NSW 1811
Phone: (02) 9647 1411
Fax: (02) 9648 3698
Email:
nsw@audiotelx.com.au

MELBOURNE

(VIC & TAS SALES)

22/277
Middleborough Road
Box Hill VIC 3128
PO Box 151 Blackburn
South VIC 3130
Phone: (03) 9890 7477
Fax: (03) 9890 7977
Email:
vic@audiotelx.com.au

BRISBANE

(QLD SALES)

42 Commercial Road
Fortitude Valley
QLD 4006
PO Box 871 Fortitude
Valley QLD 4006
Phone: (07) 3852 1312
Fax: (07) 3252 1237
Email:
qld@audiotelx.com.au

ADELAIDE

(SA & NT SALES)

31 Walsh Street
Thebarton
SA 5031
PO Box 157
Hindmarsh SA 5007
Phone: (08) 8352 4444
Fax: (08) 8352 4488
Email:
sa@audiotelx.com.au

PERTH

(WA SALES)

3/11 Howe Street
Osborne Park WA 6017
PO Box 1281
Osborne Park BC
WA 6916
Phone: (08) 9228 4222
Fax: (08) 9228 4233
Email:
wa@audiotelx.com.au

AUCKLAND

(NZ SALES)

9C Piermark Drive
Albany 0752
New Zealand
PO Box 300-512
Albany 0752
Phone: (09) 415 9426
Fax: (09) 415 9864
Email:
sales@audiotelx.co.nz

EUROPE / ASIA / MIDDLE EAST

www.australianmonitor.com.au

INTERNATIONAL SALES

1 Clyde Street Silverwater NSW 2128 Australia
Private Bag 149 Silverwater NSW 1811
Phone: (02) 9647 1411
Fax: (02) 9648 3698
Email: international@audiotelx.com.au